

THIS FILE IS MADE AVAILABLE THROUGH THE DECLASSIFICATION EFFORTS AND RESEARCH OF:

THE BLACK VAULT

THE BLACK VAULT IS THE LARGEST ONLINE FREEDOM OF INFORMATION ACT / GOVERNMENT RECORD CLEARING HOUSE IN THE WORLD. THE RESEARCH EFFORTS HERE ARE RESPONSIBLE FOR THE DECLASSIFICATION OF THOUSANDS OF DOCUMENTS THROUGHOUT THE U.S. GOVERNMENT, AND ALL CAN BE DOWNLOADED BY VISITING:

[HTTP://WWW.BLACKVAULT.COM](http://www.blackvault.com)

YOU ARE ENCOURAGED TO FORWARD THIS DOCUMENT TO YOUR FRIENDS, BUT PLEASE KEEP THIS IDENTIFYING IMAGE AT THE TOP OF THE .PDF SO OTHERS CAN DOWNLOAD MORE!

TECHNICAL REPORT

Declassified 29 MAR 95

Auth: DOD 5200.1.2

SAF/AAZD

C. S. Hancock
MRS, USAF

TR-AC-47

(Unclassified)

JOINT ATIC-WADC REPORT ON

PROJECT SILVER BUG

PROJECT NO. 9961

341-59A1818

15 FEBRUARY 1955

¹⁰
2/65-19.7.6



~~DS 55-1419~~

DS 55-1272-2

AIR TECHNICAL INTELLIGENCE CENTER

WRIGHT-PATTERSON AIR FORCE BASE

OHIO

UNCLASSIFIED

1. Information conflicting with or pertinently affecting that contained in this publication should be forwarded by the recipient directly to:

Commander
Air Technical Intelligence Center
Wright-Patterson Air Force Base, Ohio

This in no way abrogates or alters responsibility for sending such information or any pertinent intelligence data through already established intelligence collection channels of the various services or agencies of the U.S. government.

2. WARNING: This document contains information affecting the national defense of the United States within the meaning of the Espionage Law, Title 18, U.S.C., Sections 793 and 794. Its transmission or the revelation of its contents in any manner to an unauthorized person is prohibited by law.

UNCLASSIFIED

[REDACTED] UNCLASSIFIED

TECHNICAL REPORT NO. TR-AC-47

(Unclassified)

JOINT ATIC-WADC REPORT ON

PROJECT SILVER BUG

PROJECT NO. 9961

15 FEBRUARY 1955

Published by

AIR TECHNICAL INTELLIGENCE CENTER
WRIGHT-PATTERSON AIR FORCE BASE
OHIO

No copyright material is contained in this publication. T55-2049

[REDACTED] UNCLASSIFIED

TABLE OF CONTENTS

	<u>Page No.</u>
Summary	iii
Section I Characteristics	1
A. Background	1
B. Description of the Proposed Aircraft	1
C. Performance	17
Section II USAF Research and Development Status	23
A. Principal Problem Areas	23
B. Present Development Status	23

LIST OF ILLUSTRATIONS

Figure 1 Three-view General Arrangement of Proposed Multi-engine Research Aircraft	2
Figure 2 Cut Away of Research Aircraft	3
Figure 3 Three-view General Arrangement of Research Aircraft	5
Figure 4 Section Cutaway of Research Aircraft	6
Figure 5 Ground Cushion Effect	7
Figure 6 Airflow Into Intake During Take-off and Landing	11
Figure 7 Section of Airflow Pattern for Take-off	12
Figure 8 Typical Section of Exhaustor Duct Showing Take-off Gas Flow	13
Figure 9 Section Through Rear of Aircraft at Supersonic Speed	14
Figure 10 Typical Cross-Section Through Engine	15
Figure 11 Through Flow at Low Forward Speed	16
Figure 12 Cross-Section Showing Bearing Airflow	18
Figure 13 Perspective View Showing True Path of Bearing Air	19
Figure 14 Exhaust Jet Angles at Low Forward Speed	20
Figure 15 Coanda Effect: High Aspect Ratio Jet Bending	21

[REDACTED]

UNCLASSIFIED

TABLE OF CONTENTS (Cont)

	<u>Page No.</u>
Table I Physical Characteristics	8
Table II Weight Breakdown	9
Table III Contractor Estimated Performance	22

[REDACTED]

UNCLASSIFIED

[REDACTED]

UNCLASSIFIED

SUMMARY

Purpose

This report presents factual technical data on A. V. Roe, Canada, Limited, proposed development, Project Y2 (Secret). This proposal is the second of two designs which can be classified as radical aircraft designs. The ultimate purpose of presenting this is two-fold; to correct the distorted picture presented in previous releases, both classified and unclassified, and to acquaint the intelligence community with the current state-of-the-art facts thereby alerting them to any air intelligence information which may become available indicating Soviet interest in this specialized field.

Factual Data

Several news mediums have published articles concerning A. V. Roe, Canada, Limited, Project Y2 (Secret) which, when supplemented by the December Air Intelligence Digest article, "The Flying Disc", present an inaccurate picture of the proposed project. It was decided that a factual account of this project would be presented, in the form of a joint Wright Air Development Center - Air Technical Intelligence Center study, to the intelligence agencies to correct any misgivings brought about by the above-mentioned articles.

Discussion

The subject of this report deals with a proposal for a new type aircraft by one of Canada's most progressive members of the aircraft industry, AVRO Aircraft, Limited, a member of the Hawker-Siddley Group. This project should in no way be associated with any science fiction or "Flying Saucer" stories because of its external appearance. The configuration was a result of an engineering investigation into the solution of a particular problem.

An examination of the AVRO proposal shows that the potential for a very high performance weapon system exists in the not-too-distant future. Although this proposal offers the USAF a potentially advanced weapon system having both vertical take-off and military performance capabilities, there are numerous technical problems which must be solved before a successful development can be realized.

The proposal is for the design of a supersonic research aircraft having a circular planform and VTO characteristics. One version provides for the use of several conventional axial-flow engines, while the ultimate aircraft configuration utilizes a new radial-flow type engine. Another unusual feature of this proposal is that the control of the aircraft is accomplished by selective direction of the exhaust gases which eliminates the necessity of conventional aerodynamic control surfaces.

Conclusions

This proposal offers a possible solution to the USAF requirement for achieving dispersed base operations.

[REDACTED]

UNCLASSIFIED

[REDACTED]

UNCLASSIFIED

There appears to be no fundamental reason why this proposal should not ultimately result in a weapon system, however there are several technical areas which must be investigated before a full-scale development program is initiated.

The simplicity of airframe construction should alleviate many of the manufacturing and logistic problems normally associated with new aircraft developments.

Based on the above conclusions, a two-fold intelligence program is justifiable.

a. The technical information on this project should be followed by direct liaison between WADC and ATIC personnel.

b. A collection effort should be initiated to determine whether the Soviet Bloc is or has been conducting research efforts on a similar project, when this work began, and the present state of the Soviet development.

[REDACTED]

UNCLASSIFIED

[REDACTED]

UNCLASSIFIED

SECTION I

CHARACTERISTICS

A. Background

There is a USAF requirement to develop means of operation from dispersed bases. This requirement stems from the growing and possibly catastrophic vulnerability of conventional air bases. The major feature of conventional air bases is the runway, which has grown wider, thicker, and longer as aircraft have become heavier and faster. The operational necessity of runways leads to concentrations of aircraft which have become critical targets. The logical approach to dispersed base operation would then appear to be toward reducing the length of runways or to their total elimination. Numerous schemes have been proposed, investigated, and some developed to reduce the take-off distance of aircraft. Among them are water ejection, after-burning, and RATO. Drag chutes and methods of thrust reversal have been developed for reducing landing requirements. Attempts to eliminate runways completely have resulted in helicopters, convertiplanes and what is known as VTO aircraft.

There are two general types of VTO aircraft - "tail-sitters" and "flat-risers". A flat-riser takes off in the vertical direction in a normal horizontal flight attitude, while the tail-sitter takes off vertically from a position which is 90 degrees to a normal level horizontal flight attitude. Examples of tail-sitters are the United States Navy projects with Lockheed and Convair which utilize a turboprop power plant, and the USAF project with Ryan Aeronautical Corporation utilizing turbojet power plants. Examples of the flat-riser are the Rolls-Royce "Flying Bedstead" and the Bell VTO aircraft. The basic design problem associated with any aircraft of this type becomes one of achieving in a single vehicle VTO and military performance capabilities. A possible solution to this problem has been proposed by A. V. Rce, Canada, Limited, in the form of their Project Y2 (Secret).

B. Description of the Proposed Aircraft

1. General Description

Two versions of small research VTO aircraft have been designed by the contractor, which, by company designation, are Project Y (Secret), a "tail-sitter", and Project Y2 (Secret), a "flat-riser". Early in the investigation, Project Y (Secret) was rejected by the contractor in favor of the flat-riser. Project Y2 (Secret) design proposal incorporates a number of advance improvements brought about by the utilization of several radical ideas in fundamental areas which, as yet, have not been thoroughly investigated. The original proposal was essentially for the construction of a very large radial-flow gas turbine engine which, when covered, will form a flying wing with a circular platform, similar in appearance to a very large discus. The engine is designed to fly "edge-on" to the wind instead of axially as is the present practice in conventional aircraft design. An alternate version for a multi-engine aircraft as shown in Figures 1 and 2 would avoid concurrent development of the airframe and engine while providing the other essential characteristics of the vehicle.

[REDACTED]

UNCLASSIFIED

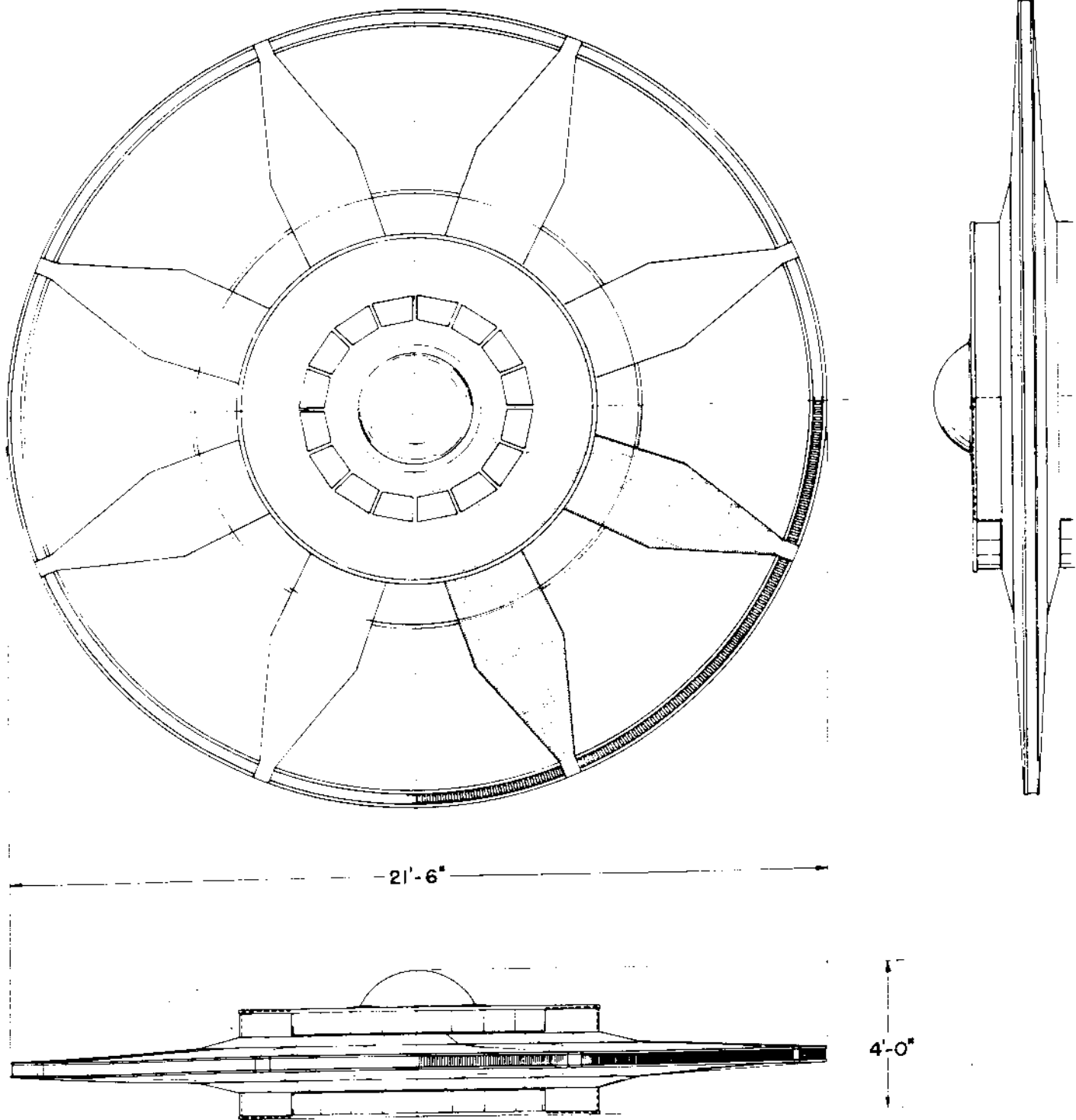

Fig. 1 Three-View General Arrangement of Proposed Multi-Engine Research Aircraft

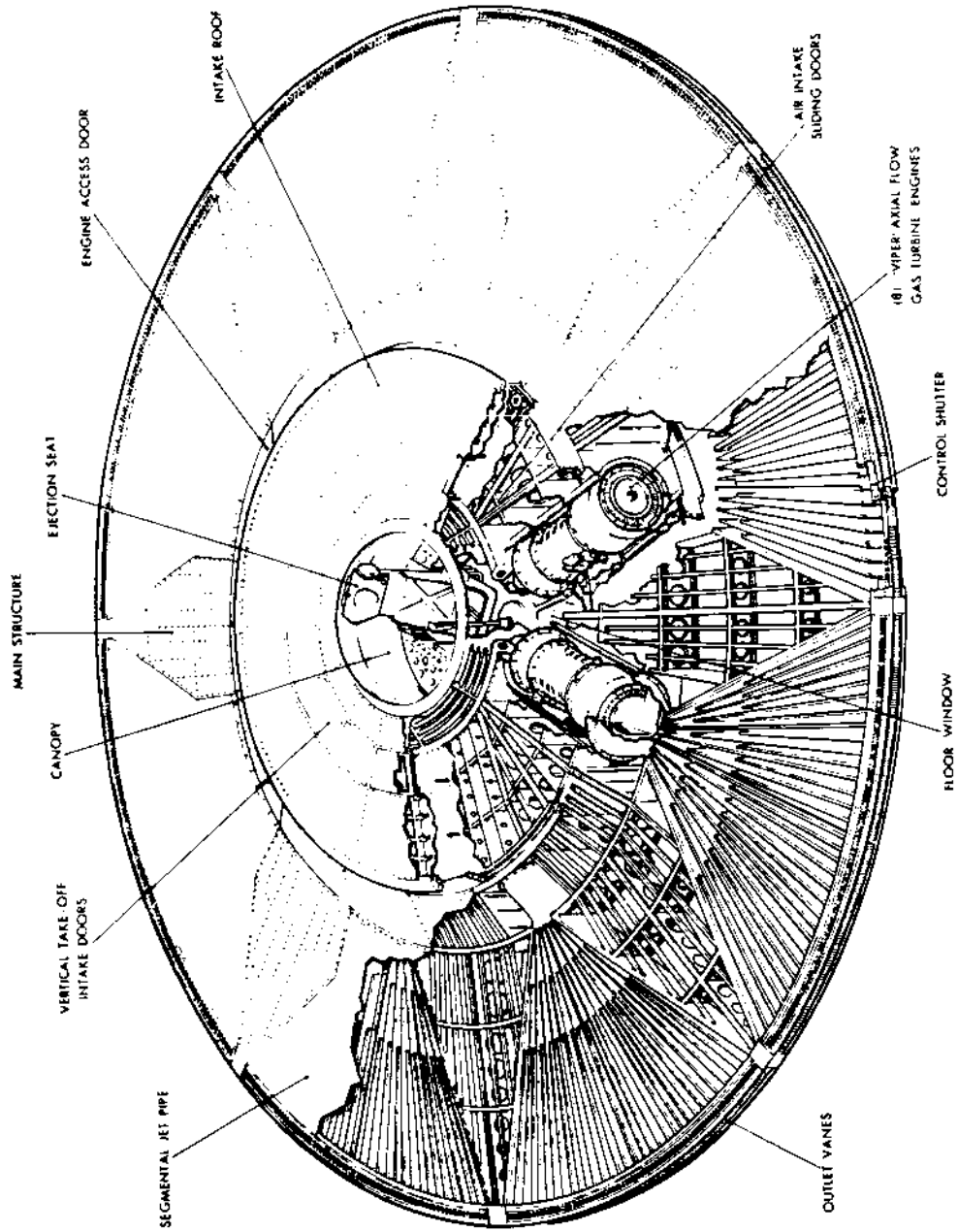

Fig. 2 Cut Away of Research Aircraft

The cockpit is located at the center of the aircraft with the orientation of the cockpit determining the fore and after center-line of the aircraft as well as the normal direction of forward flight. The airframe, fuel cells, and the gas turbine power plant encircle the cockpit. (See Figs 3 and 4.)

This aircraft is designed for vertical take-off and landings while in the horizontal flight attitude, i.e., a "flat-riser". Since this aircraft rises vertically from a horizontal position, it does not require a landing gear or auxiliary landing devices. The flat-riser flight take-off technique, the elimination of the landing gear and auxiliary landing devices, are brought about by the peripheral exhaust which produces a "powerful ground cushion effect" (Fig 5). This is one of the fundamentals upon which this new radical aircraft design is based.

Since this airframe and engine will have a circular planform, the outer perimeter of the aircraft will be the exhaust nozzle of the engine and the thrust forces will be used for control of the aircraft. A unified control system must be designed which will produce the same aircraft responses irrespective of whether the aircraft is in hovering, transition, or forward flight. The circular planform may be modified to accommodate trim flaps of some nature if they are found to be necessary.

The air intakes are placed in the inner circle on the upper surface of the aircraft for vertical take-off while additional air intakes are installed in the upper and lower forward facing surfaces for forward flight.

A multi-engine configuration (Figs 1 and 2) is proposed as a research vehicle for the purpose of investigating stability and control, performance, etc., before development of a multi-engine operational aircraft or radial-flow single-engine aircraft. This prototype configuration will also investigate certain fundamental areas concerning aircraft behavior; an example is the ground cushion effect.

2. Airframe

The cutaway (Fig 4) of the research aircraft with the radial-flow engine shows the details of the aircraft structure. The center location of the fuel cells allows for the use of the fuel as a coolant medium against aerodynamic heating for the cockpit. The mechanical engineering details should not present any unsolvable problems in the airframe design; however, the rotor assembly and exhaust control systems are considered major problems. The basic structural ribs of the airframe lend themselves readily to mass production since they are identical. Sixty ribs are proposed as the foundation of the airframe. These ribs are "butted" to the outer surface of the fuel cells with the inner side of the fuel cells comprising the cockpit opening. For the multi-engine version (Figs 1 and 2) certain engineering problems may arise due to the complexity of controlling eight engines, eight fuel systems, eight lubricating systems, etc.

3. Air Intake

The aircraft, at rest, cannot use the bottom forward facing air intake, therefore, "take-off air is supplied through 30 square feet of releasing door area

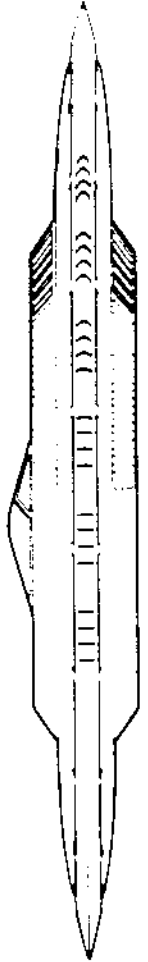
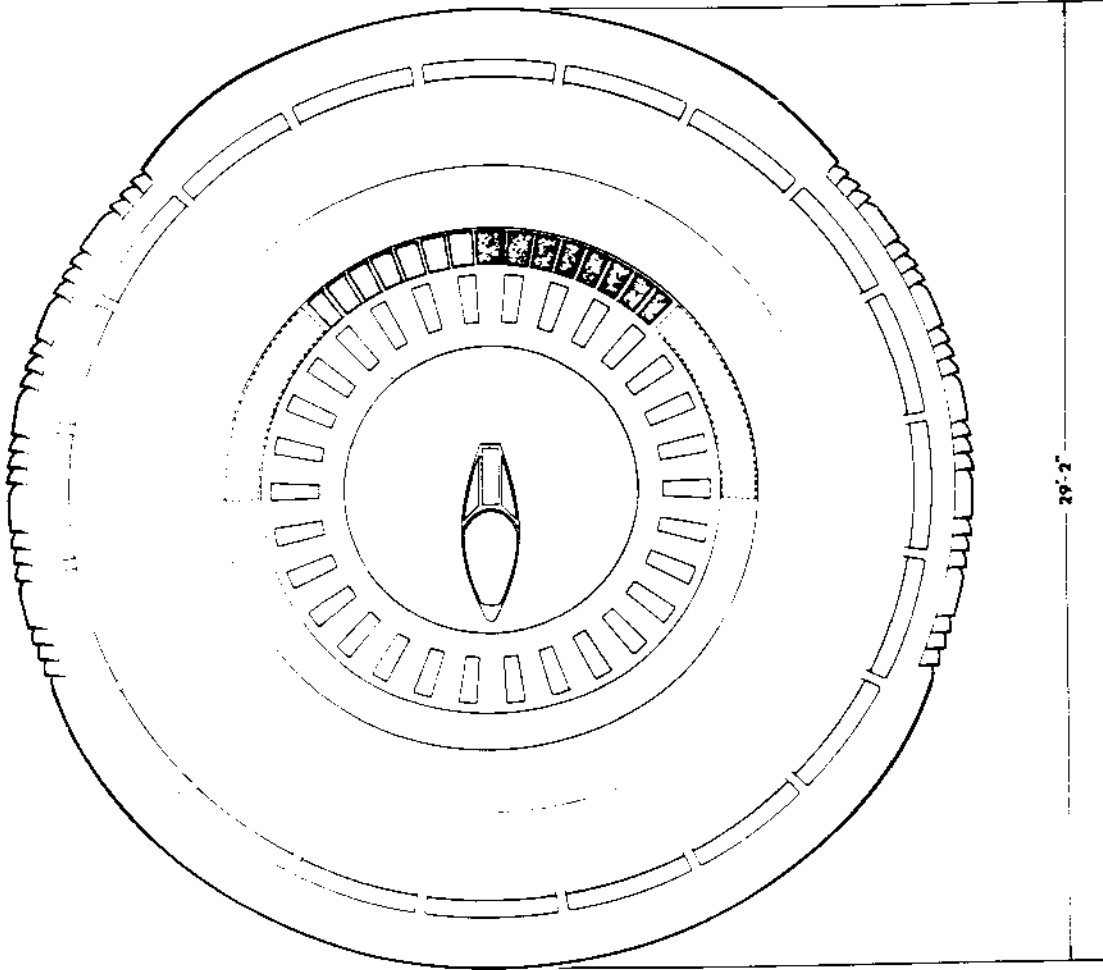
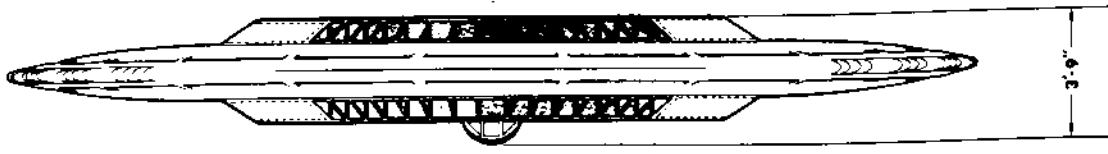

Fig. 3 Three-View General Arrangement of Research Aircraft

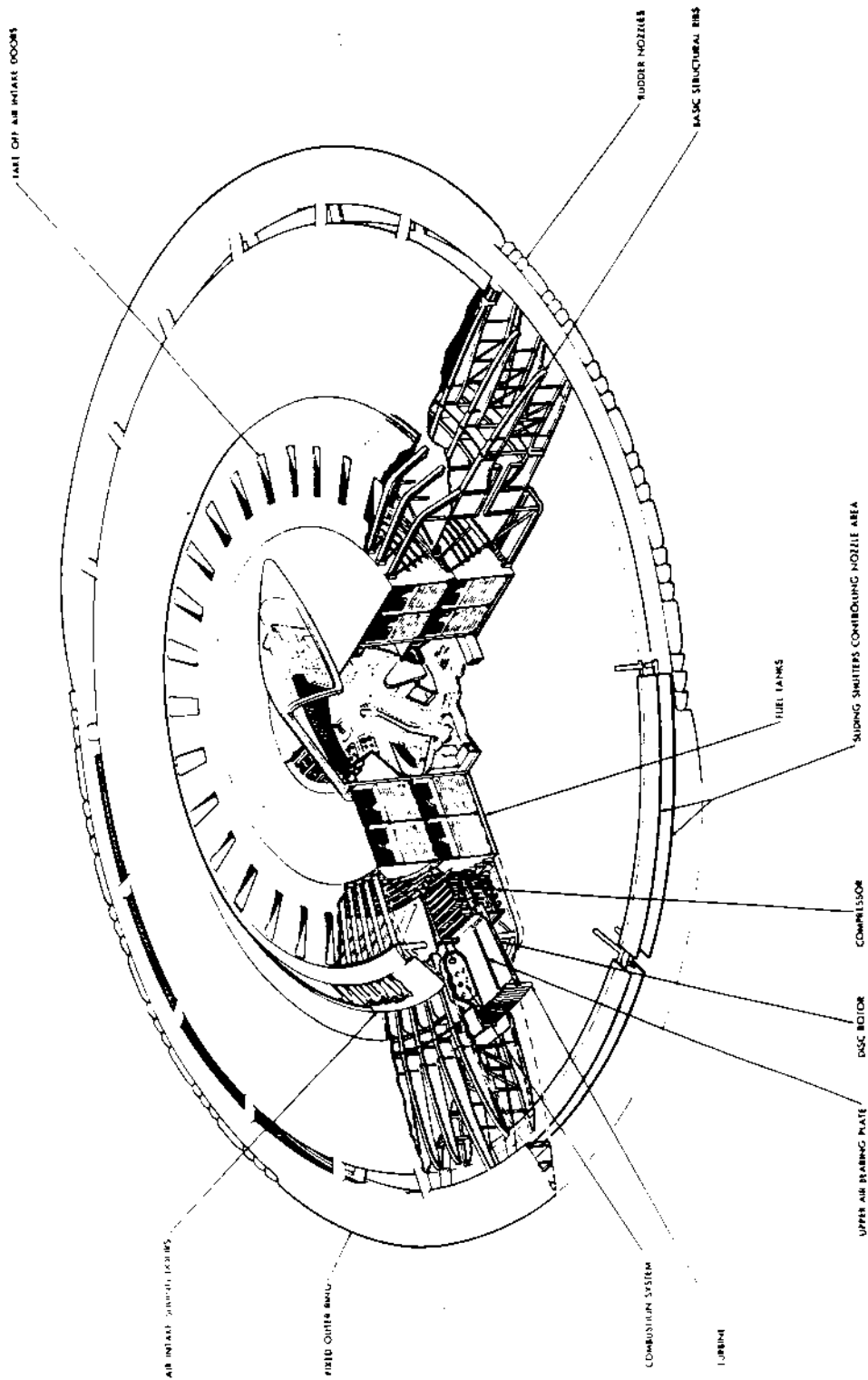

Fig. 4 Section Cutaway of Research Aircraft (Radial Flow Engine)

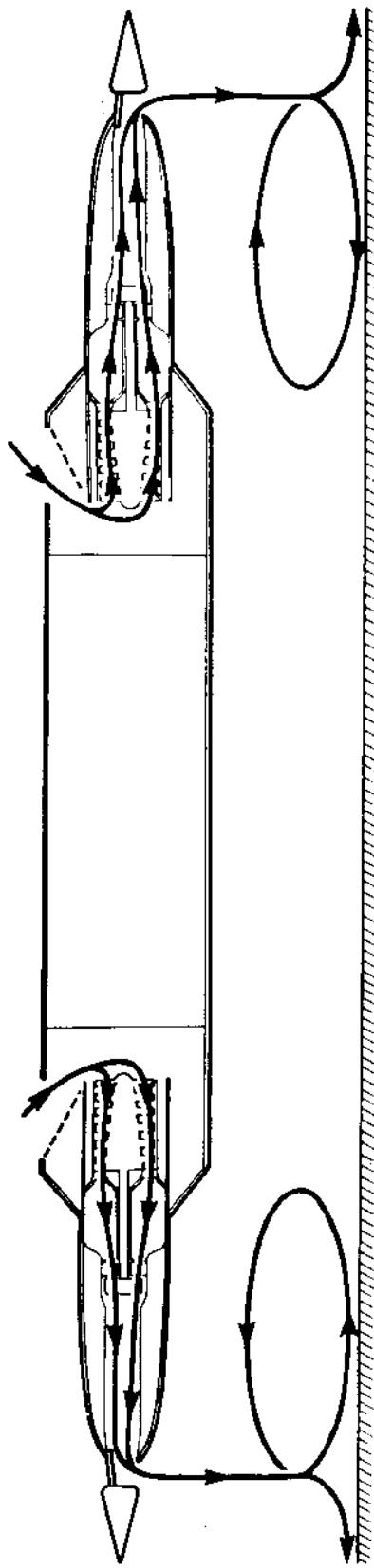

Fig. 5 Ground Cushion Effect

TABLE I

PHYSICAL CHARACTERISTICS

Radial-Flow Engine Aircraft

Particulars		Values
Weight Dimensions, etc.		
Aircraft Gross Take-off Weight	lb	29,000
Gross wing area	sq ft	670
Span (= diameter)	ft	29.2
Height over canopy	ft	3.75
Standard mean chord	ft	23.0
Aspect ratio	--	1.27
Mean t/c ratio excluding intake	--	0.06
Intake base area	sq ft	20.0
Approximate jet base area in forward flight	sq ft	16.0
Wing loading at mean weight of 26,000 lbs	lb/sq ft	38.8
Maximum internal fuel	Imp gal	950
	U.S. gal	1,140
Take-off thrust/weight ratio	--	1.73
SLS thrust/frontal area	lb/sq ft	900

TABLE II

WEIGHT BREAKDOWN

Radial-Flow Engine Aircraft

Particulars	Lb	Totals
Aircraft Main Structure		9,532
Cockpit well and fuel tank	696	
Intake structure	1,341	
Main structure	2,904	
Outer wing and exhauster	2,990	
Halo	781	
Cockpit and canopy	165	
Control shutters	410	
Control system	245	
Power Plant		10,450
Rotor assembly	5,750	
Stator blades, plates and attachments	2,120	
Combustion system	1,180	
Air bearing assembly	1,400	
Extra to structure		1,068
Cockpit equipment	118	
Radio and electrics	352	
Fuel system	284	
Air conditioning and oxygen	250	
Miscellaneous	84	
AIRCRAFT EMPTY WEIGHT		21,050
Disposable Load		7,950
Crew	200	
Fuel	7,750	
AIRCRAFT GROSS TAKE-OFF WEIGHT		29,000

in the top intake." This air is exhausted through exhaust nozzle (outer perimeter) of the aircraft and is directed downward (see Figs 6 and 7). This downward ejection of the air produces a "ground cushion effect", (see Fig 5) which results in an additional thrust component for take-off and allows for a ground cushion to brake the landing of the aircraft. This effect is present only when the exhaust air is distributed from the periphery of the aircraft (flat-risers). (See Fig 8.)

In forward flight, the air enters the plenum chamber through the forward facing air intakes in both the upper and lower surfaces of the aircraft. Engine exhaust gases are carried around the exhauster duct and are expelled through the annular nozzle which is located on the upper and lower surfaces near the periphery, and through the backward facing nozzles which are located on both sides of the aircraft. (See Fig 9.)

4. Propulsion System

The proposed power plant for the single-engine research vehicle is basically a double-sided radial-flow turbojet engine. The heart of this engine is a very large diameter rotor disc which utilizes compressor air bleed as its only means of lubrication.

The compressor stators, diffuser, combustion tubes, and turbine nozzle guide vanes are designed as an integral part of the airframe. The rotating element of the conventional gas turbine engine, namely, the compressor rotor, connecting shaft and turbine wheel have been rearranged to a disc configuration. The compressor rotor blades are mounted vertically on the inner disc ring; the turbine wheel blades are mounted vertically on the outer disc ring, and the connecting disc ring is comparable to the conventional connecting shaft. This disc rotates on a double-sided air bearing mounted between the upper and lower combustion tubes.

The combustion system consists of flame tubes distributed between the structural ribs of the aircraft. The engine pressure is contained between the outer skin and the rotor bearing plates with the latter structure being mounted between the combustion tubes. For take-off the intake air is brought through the top intakes to the first stage of the rotor and is compressed radially outward through six stages giving a normal pressure ratio of 3 to 1. From the last compressor stage, the air is diffused and passes through the flame tubes, turbine inlet guide vanes, through the turbine wheel, and then through the exhaust nozzle which is the outer perimeter of the aircraft. (See Fig 10.) During forward flight, the upper air intake ducts are closed and the forward facing air intakes are open. (See Fig 11.)

Due to the radial flow through the engine, the compressor blades and turbine blades are straight. Therefore, these parts may be more easily manufactured than for the conventional engine compressors and turbines.

The proposed air bearing supporting the rotating element eliminates many of the problems which are imposed by mechanical type bearings. The large area of the bearing surface, approximately 100 square feet on both sides, is available to support the weight of the very large turbine rotor. The air supply for the flat bearing comes from "secondary air" in the combustion region while the supply for the

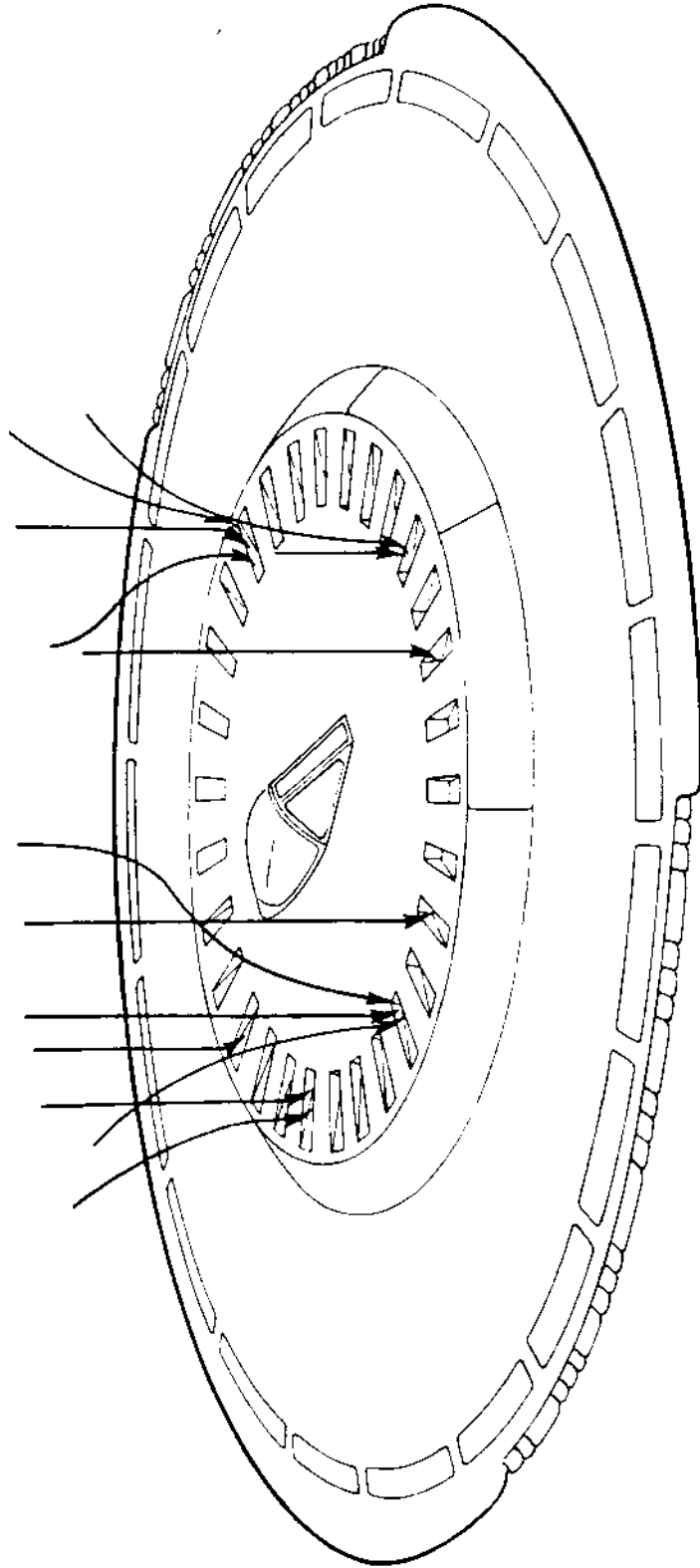

Fig. 6 Airflow Into Intake During Take-off and Landing

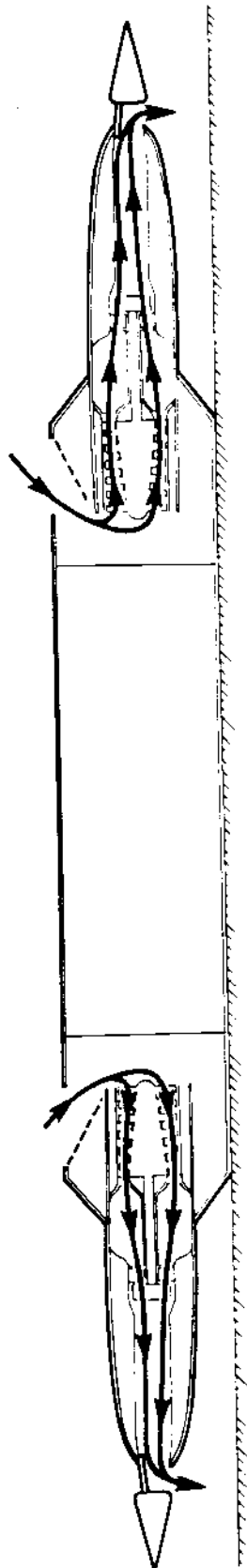

Fig. 7 Section of Airflow Pattern for Take-off

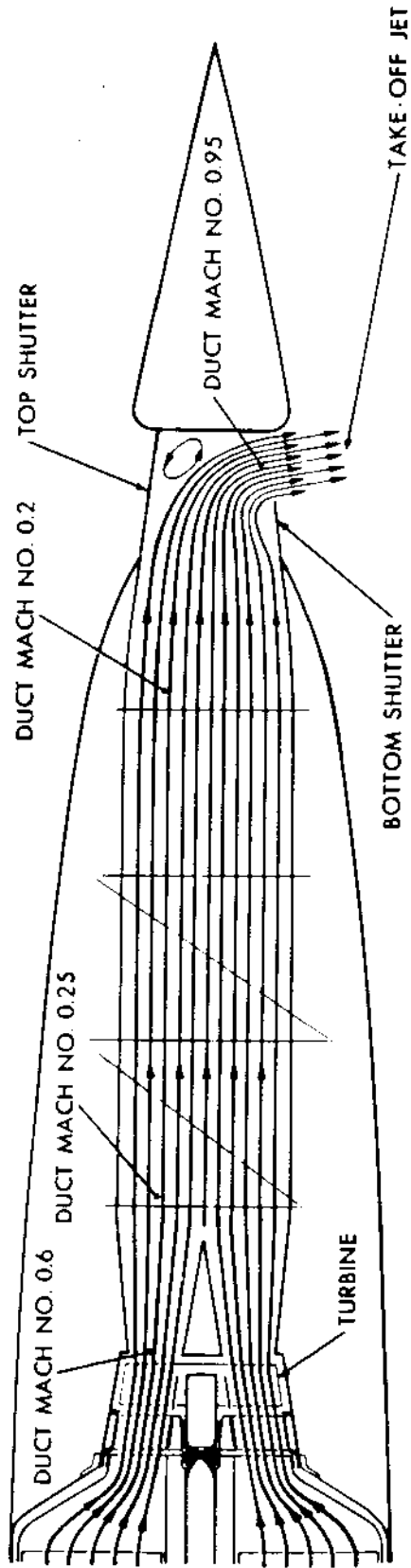

Fig. 8 Typical Section of Exhaustor Duct Showing Take-off Gas Flow

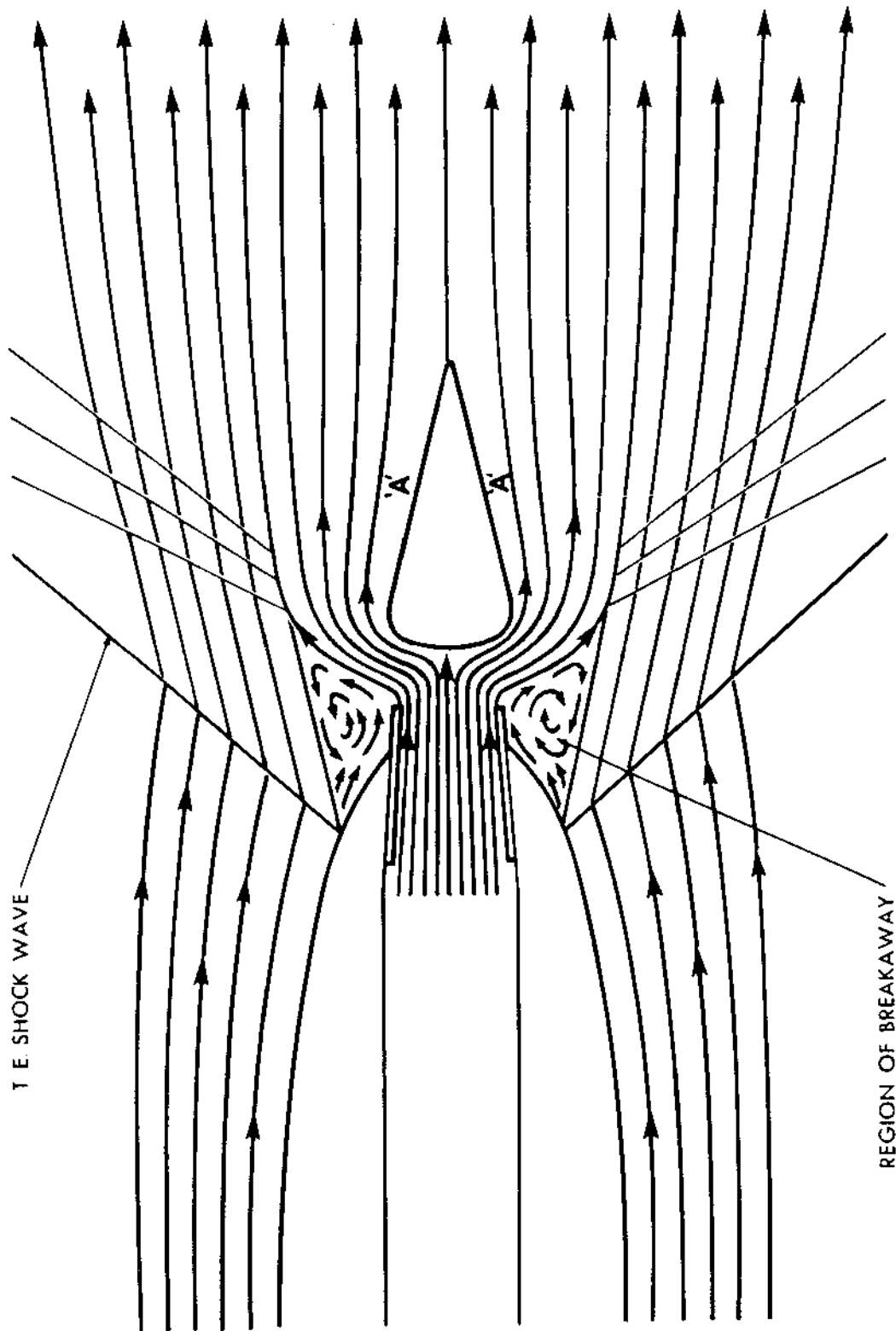

Fig. 9 Section Through Rear of Aircraft at Supersonic Speed

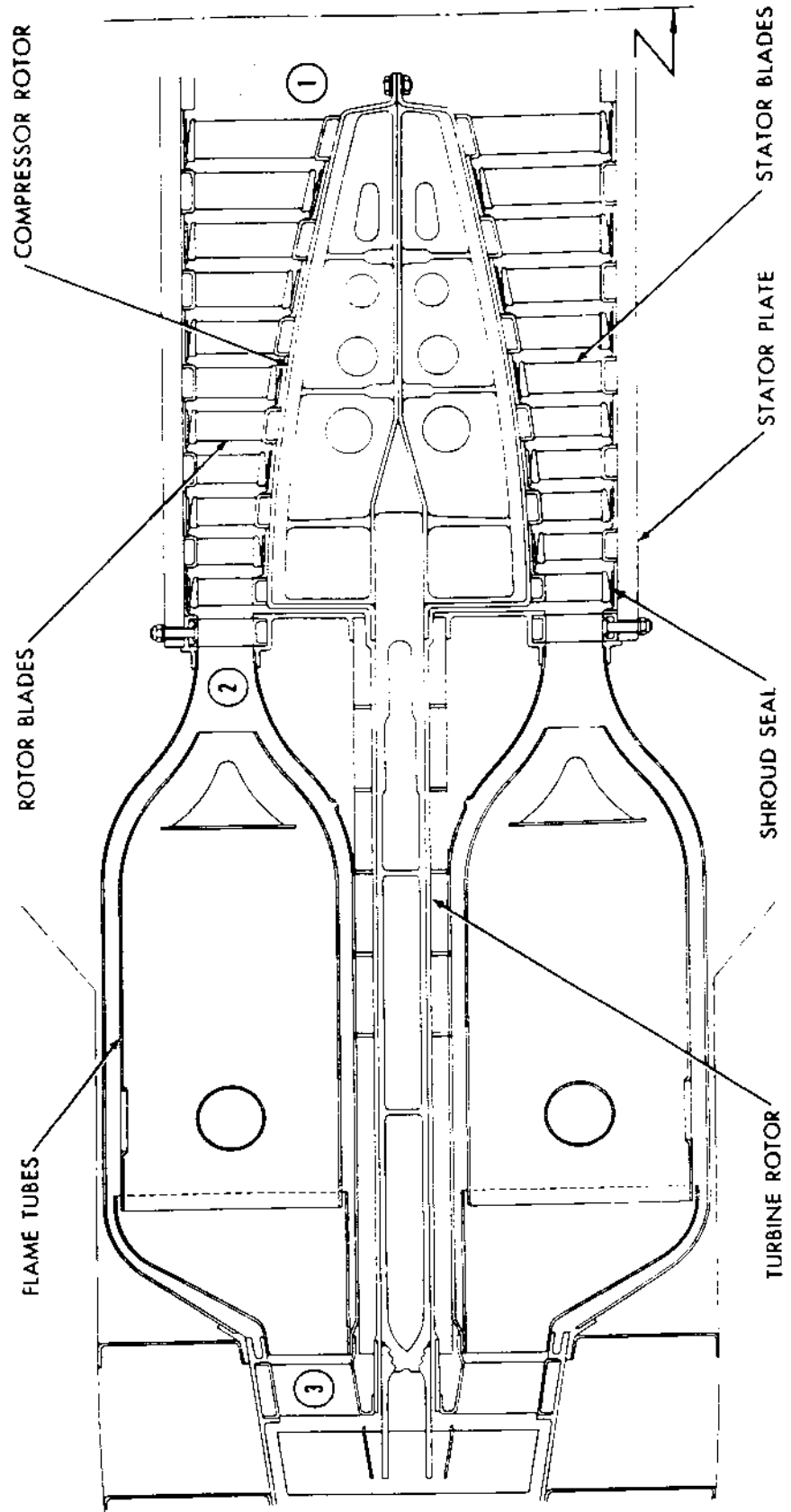

Fig. 10 Typical Cross-Section Through Engine

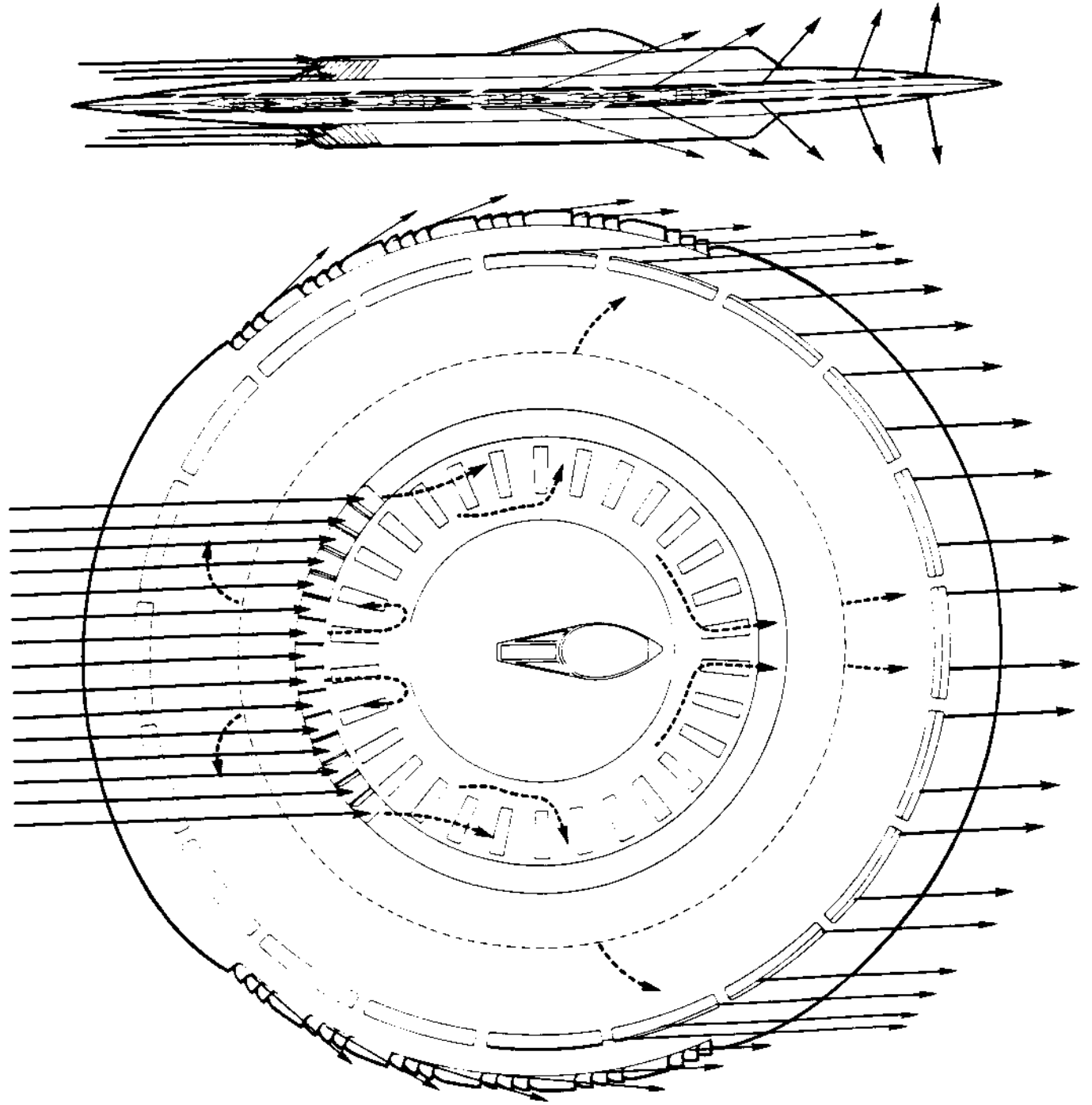

Fig. 11 Through Flow at Low Forward Speed

UNCLASSIFIED

vertical bearing comes from the rear of the last rotor stage of the compressor. Exhaust of the bearing air is controlled by a low pressure annulus and the main "exhauster" which utilized this air for cooling the turbine blade roots. Figures 12 and 13 show graphically the flow within the air bearing.

A ground supply of compressed air applied to air bearing will be used when starting the engine. In stopping the engine, the rotor will ground on self-lubricating bearing pads. The material used in the self-lubricating bearing pads will be cast iron or carbon which will provide good dry bearing surfaces on steel. These pads are not expected to suffer excessive wear or provide undue stopping torque on the turbine rotor.

The multi-engine version would utilize numerous small engines having low specific weights to provide the exhaust gases.

5. Control Systems

The aircraft is controlled by regulating shutters which vary the amount of thrust through the annular nozzles (for pitch and roll control) and through the backward facing nozzles for yaw control located on the peripheral edge. (See Fig 14.) The contractor claims that the use of this "jet control" at all times eliminates the difficulty associated with hinged control surfaces in supersonic flight. This statement on the part of the contractor is based on initial testing of the principle and much more data must be assembled before it can be completely accepted.

A proposed method of achieving jet control utilizes the so-called "Coanda effect" whereby a jet stream is deflected through large angles by having a curved surface in contact with its edge at one side. (See Fig 15.) Additional investigation into the mechanism required to utilize this effect must be accomplished in the early phases of this development.

In the proposed aircraft thrust forces are used for control at all times. It is mandatory to use the thrust force for take-off and hovering flight since there are no aerodynamic forces available due to the lack of forward movement. In forward supersonic flight thrust forces are used in lieu of conventional hinged-type controls. Some thought has been given to the mechanics of the control system as can be seen in Fig 14.

C. Performance

The performance estimated by the contractor was based on rather broad assumptions and has not as yet been investigated by a wind tunnel test program. (See Table III.)

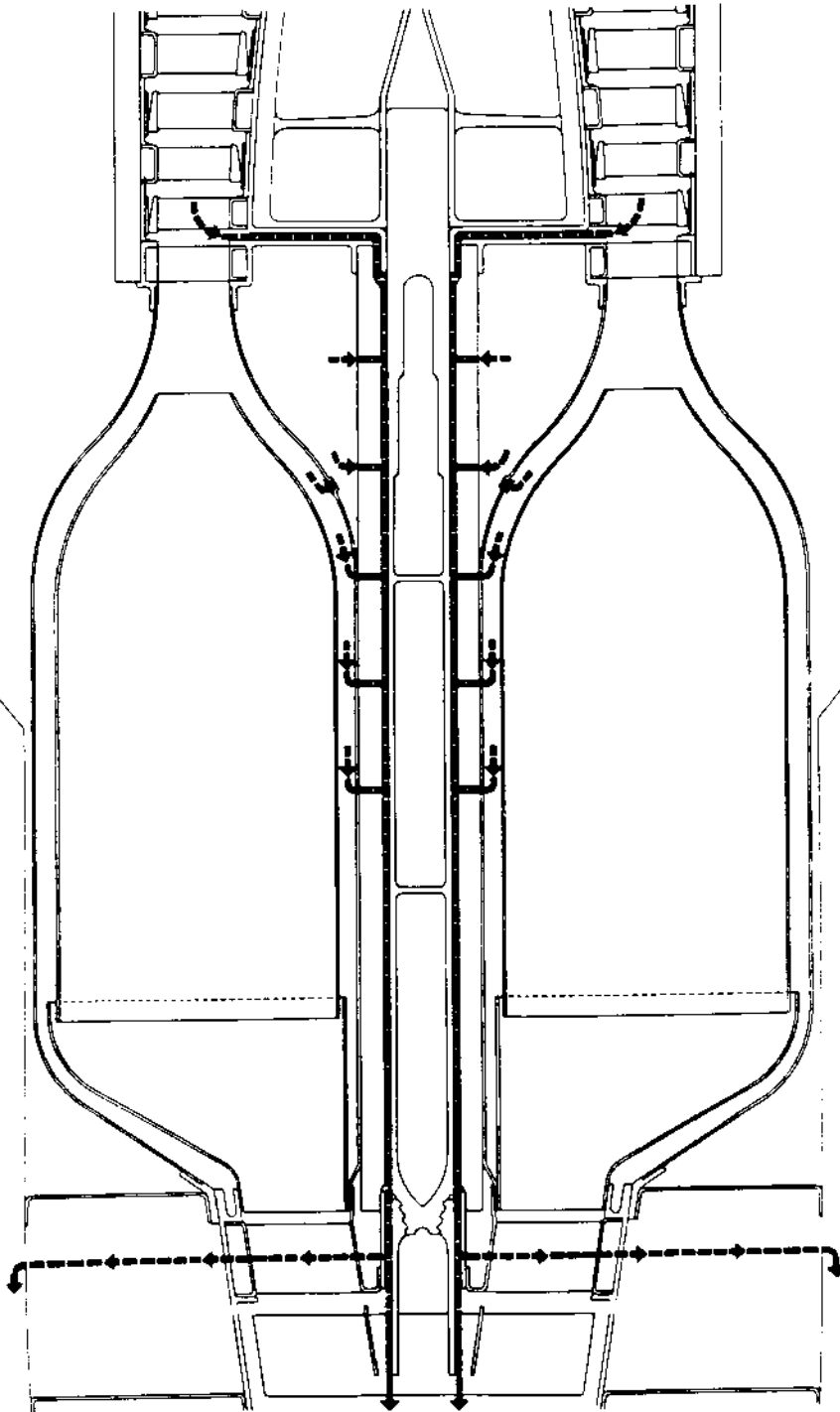

Fig. 12 Cross-Section Showing Bearing Airflow

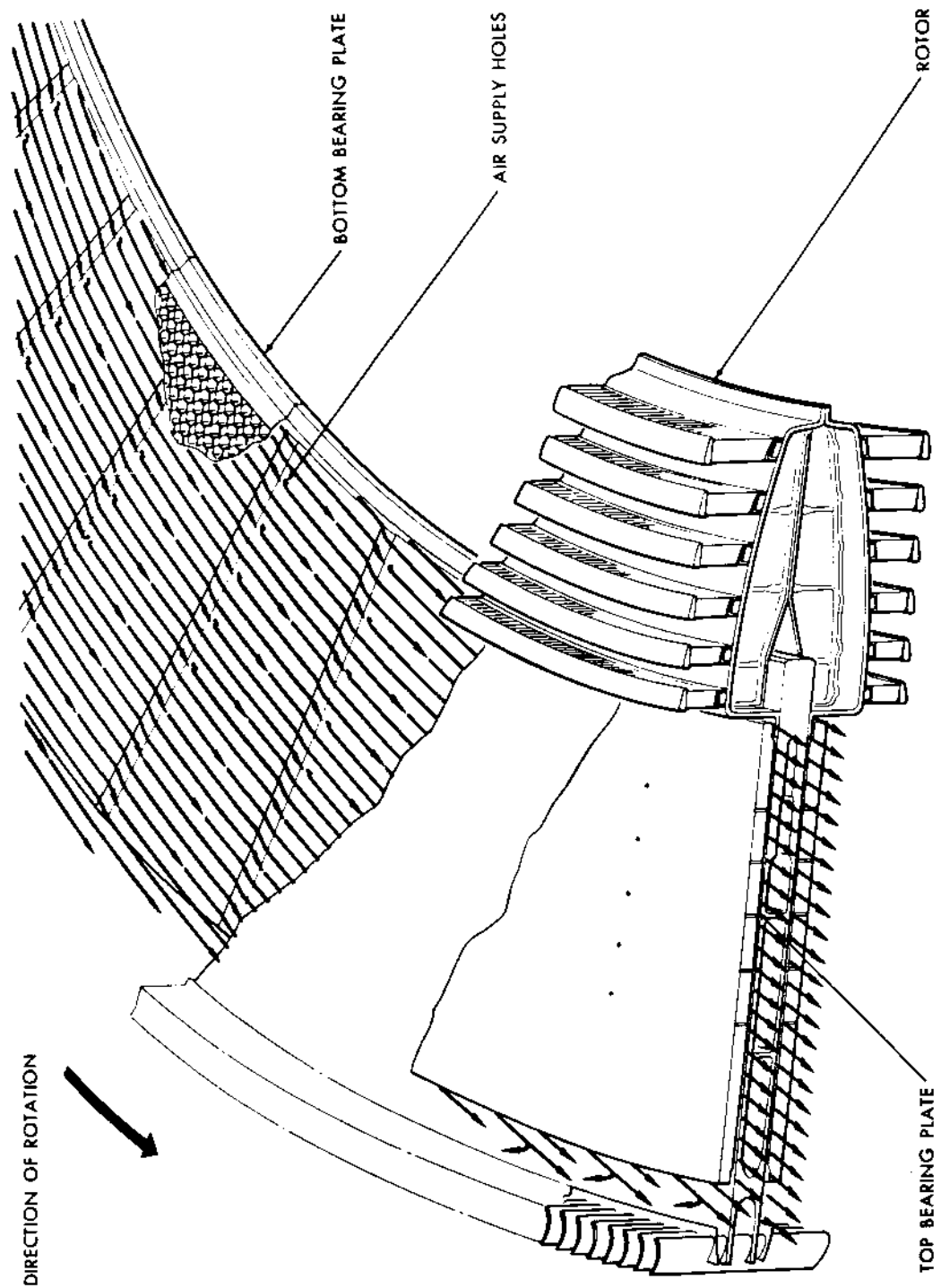

Fig. 13 Perspective View Showing True Path of Bearing Air

[REDACTED]

UNCLASSIFIED

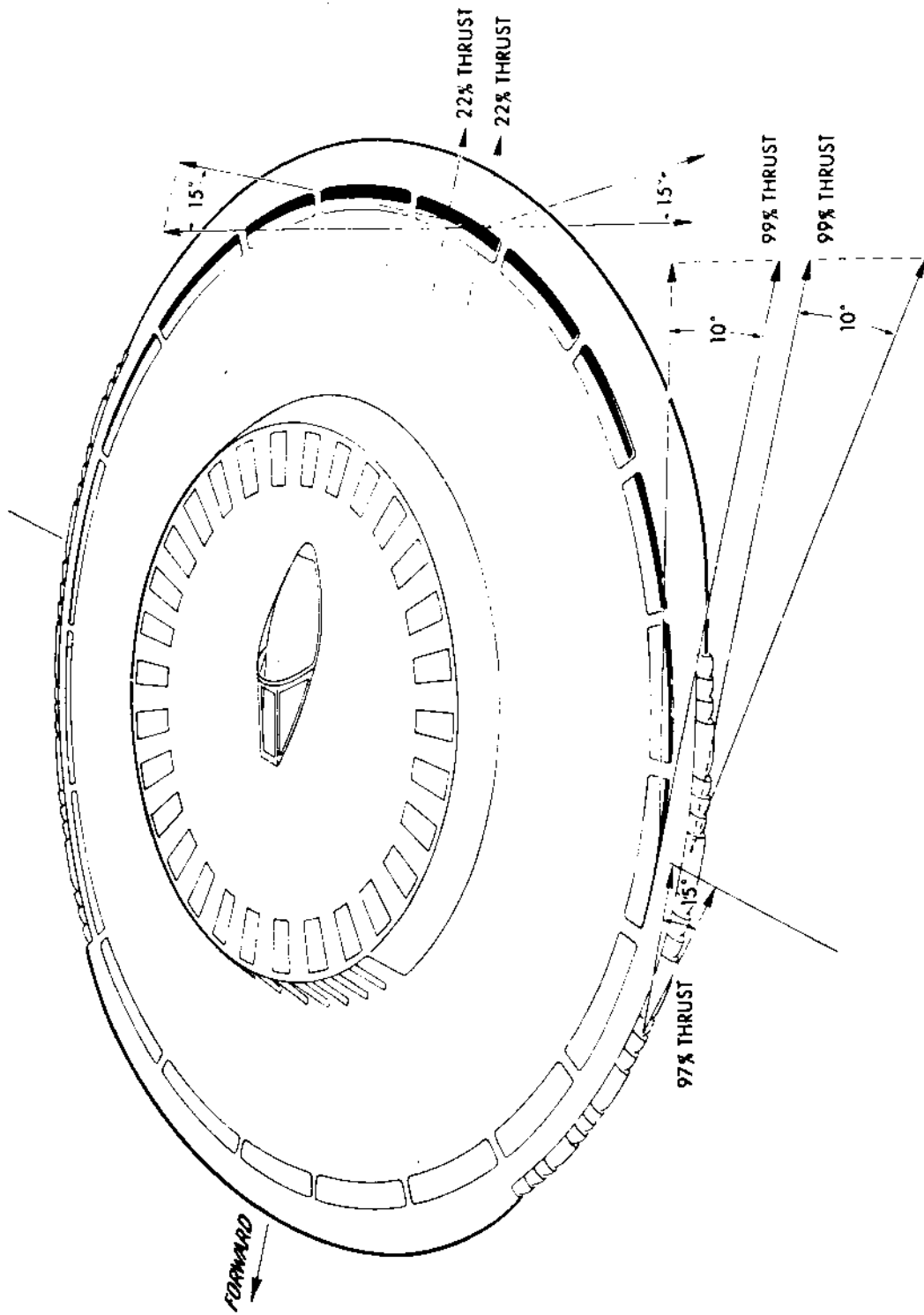

Fig. 14 Exhaust Jet Angles at Low Forward Speed

[REDACTED]

UNCLASSIFIED

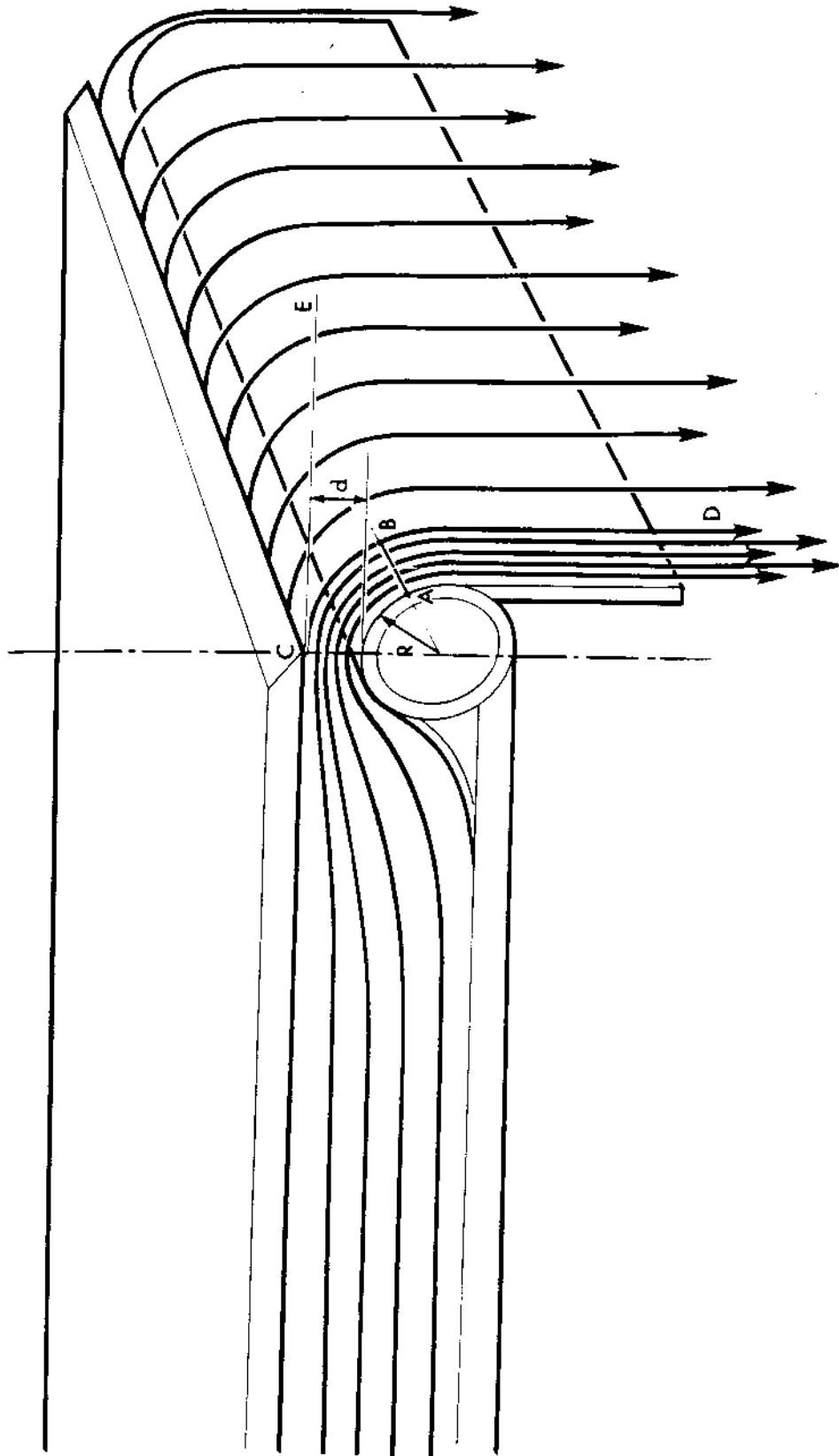

Fig. 15 Coanda Effect: High Aspect Ratio Jet Bending

TABLE III

COMBACTOR ESTIMATED PERFORMANCE

Radial-Flow Engine Aircraft

Particulars		Without Reheat	With 1500°K Reheat	
Maximum level speed	mph	1,720	2,300	
	knots	1,490	2,000	
	Mach No.	2.6	3.48	
Ceiling (Max power at mean wt)	ft	71,600	80,600	
Time from hovering start to				
	36,090 ft	min	1.76	NA
	60,000 ft	min	2.66	NA
70,000 ft	min	4.2	NA	
Still air range with allowances for take-off, climb, cruise, descent, and landing				
	miles	620	NA	
Take-off and landing distances	--	Nil	Nil	
Max hovering alt from take-off	ft	10,000	NA	
Max hovering alt at mean wt, 26,000 lbs	ft	18,000	NA	

NOTE: The above estimate utilizes net thrusts and SFC which are based on the "simplifying assumption" - "Plain nozzles and 100 per cent thrust recovery from the jet bending."

SECTION II

USAF RESEARCH AND DEVELOPMENT STATUS

A. Principal Problem Areas

In the preceding section we have presented very briefly the thought involved in A. V. Roe's design proposals for Project Y2 (Secret). The Wright Air Development Center has evaluated the detail proposals and feels that a one-year study contract which will investigate the following major areas must be accomplished before any further consideration can be given to a development contract for a research vehicle. These areas are:

- a. The air cushion effect
- b. The stability of the multi-engine configuration
- c. Air intake and exhaust systems
- d. Aircraft performance stability and control
- e. The radial-flow engine feasibility.

B. Present Development Status

Headquarters USAF directed that Headquarters ARDC would issue a technical requirement to pursue investigation of this project. This resulted in Technical Requirement No. 3 dated 13 August 1954, which in turn resulted in a development plan dated 15 September 1954, written by WADC, Directorate of Weapons Systems Operations, Bombardment Aircraft Division, New Development Office. Work on this project was delayed pending a decision by higher headquarters. On 29 December 1954 the order to proceed with this project was issued. The proposed statement of work dated 8 November 1954 will be incorporated in a study contract in the near future.